

## SMall

*Complete line of amplified subminiature photoelectric sensors*

- 15mm, 20mm, 30mm and 50mm fixed focus proximity
- 1,5m retroflective and 1m polarized retroflective
- 2m through beam models
- Amplified NPN or PNP output with NO-NC output



### APPLICATIONS

- Processing and Packaging machinery
- Automotive
- Beverage & Bottling
- Vending machines



SM-all		
Through beam		0...2 m
Retroreflective (on R2 reflector)		0,05...1,5 m
Polarized retroreflective		0,1...1 m
Fixed focus		3...15 mm
		3...20 mm
		3...30 mm
		3...50 mm
Power supply	Vdc	10...30 V
	Vac	
	Vac/dc	
Output	PNP	▪
	NPN	▪
	NPN/PNP	
	relay	
	other	
Connection	cable	▪
	connector	
	pig-tail	
Approximate dimensions (mm)		8x23x12
Housing material		Polycarbonate
Mechanical protection		IP67

TECHNICAL DATA

Power supply	10 ... 30 Vdc (limit values)
Ripple	10% max.
Consumption (output current excluded)	20 mA max.
Light emission	red LED 640 nm
Operating mode	LIGHT mode on N.O. output/DARK mode on N.C. output
Indicators	yellow OUTPUT LED excl. mod. G00 green POWER LED
Output	PNP or NPN; NO; NC
Output current	50 mA max.
Saturation voltage	1,25 V max. (NPN), 1,45 V max. (PNP)
Response time	700 µs 1,3 ms (mod. SM...F00/G00)
Switching frequency	700 Hz 385 Hz (mod. SM...F00/G00)
Connection	2 m cable Ø2,5 mm
Dielectric strength	500 Vac, 1 min between electronics and housing
Insulating resistance	>20 MΩ, 500 Vdc between electronics and housing
Electrical protection	class 2
Mechanical protection	IP67
Ambient light rejection	according to EN 60947-5-2
Vibrations	0,5 mm amplitude, 10 ... 55 Hz frequency, for every axis (EN60068-2-6)
Shock resistance	11 ms (30 G) 6 shock for every axis (EN60068-2-27)
Housing material	Polycarbonate
Lens material	PMMA, glass (mod. B00)
Operating temperature	-20 ... 55 °C
Storage temperature	-30 ... 75 °C
Weight	22 g

DIMENSIONS

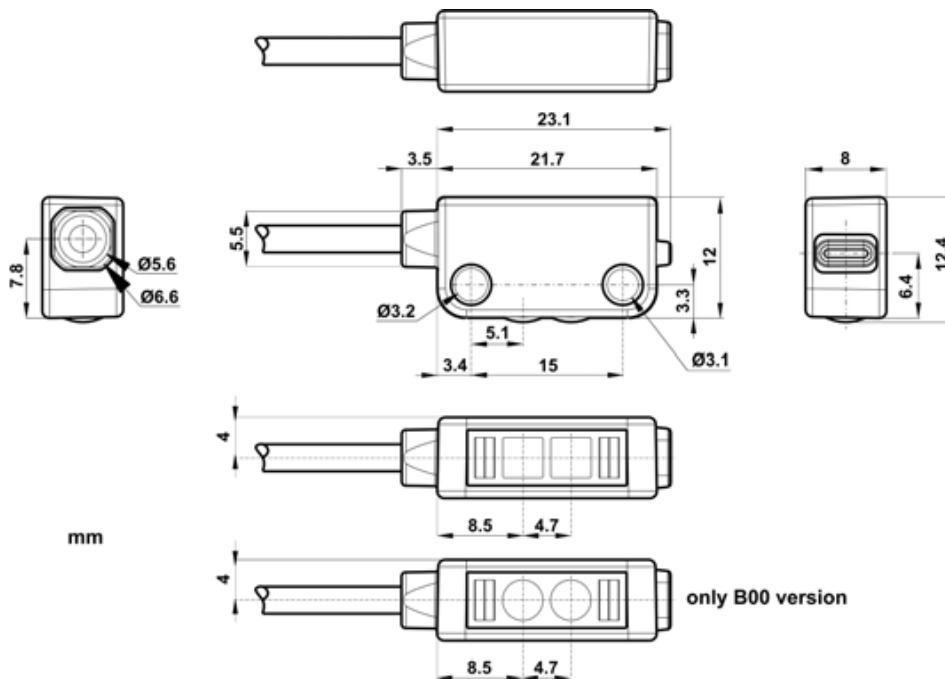

# MINIATURE SENSORS

## CONNECTIONS

### CABLE

Through beam emitter

BROWN 1 + 10 ... 30 Vdc

WHITE 2 N.C. OUTPUT

BLACK 4 N.O. OUTPUT

BLUE 3 0 V

BROWN 1 + 10 ... 30 Vdc

BLUE 3 0 V

### INDICATORS AND SETTINGS

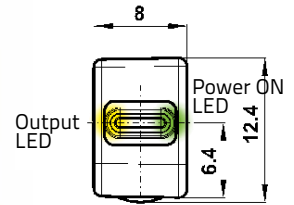

## DETECTION DIAGRAMS

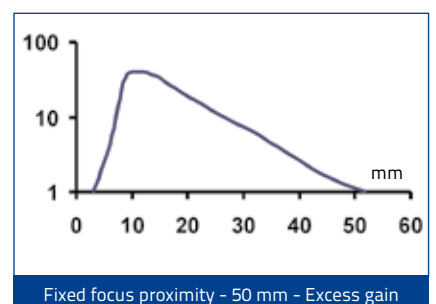
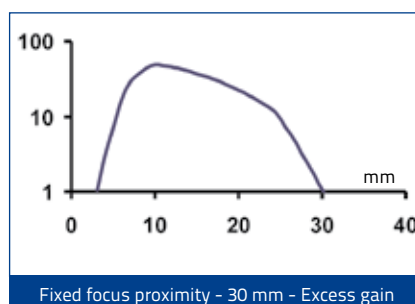
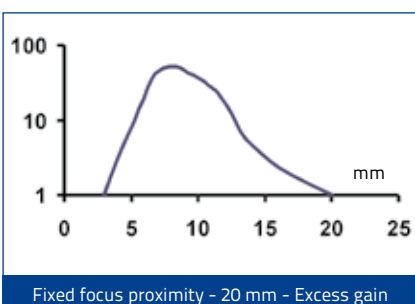
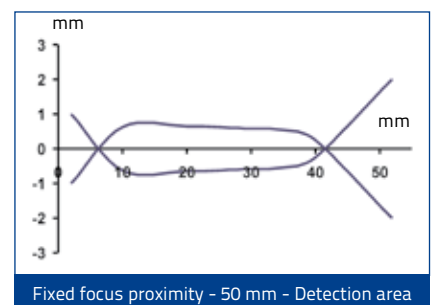
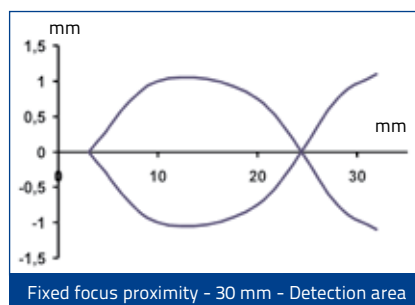
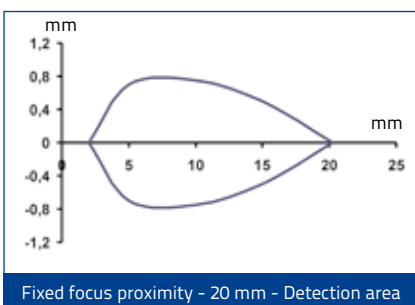
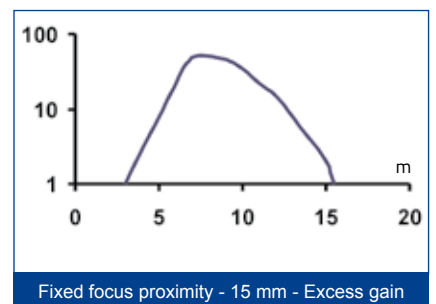
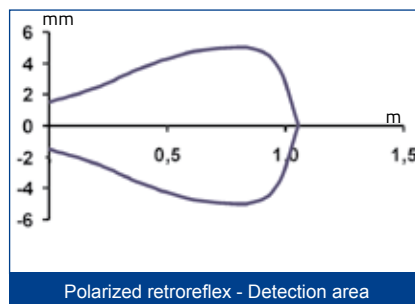
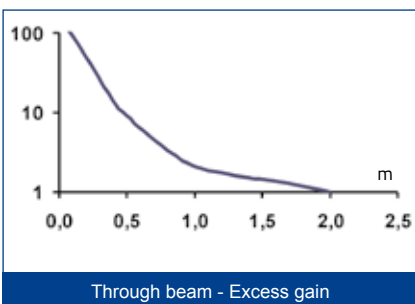
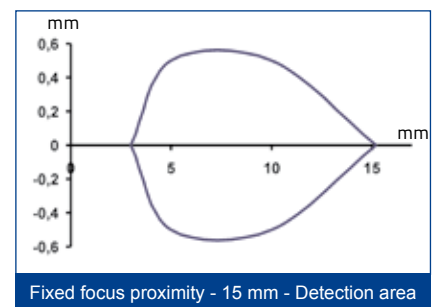
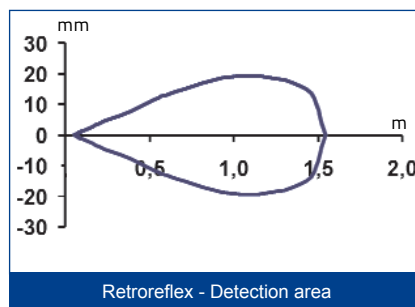
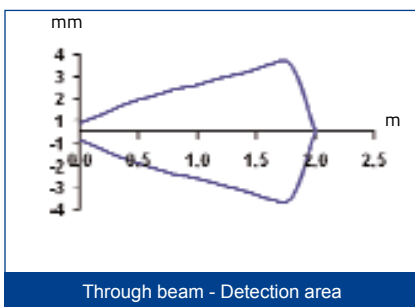

## MODEL SELECTION AND ORDER INFORMATION

OPTIC FUNCTION	OPERATING DISTANCE	CONNECTION	OUTPUT	MODEL	ORDER No.	
Retroreflective	0,05...1,5 m	2m Cable	PNP	SM-PR-2-A00-PP	95B000060	
			NPN	SM-PR-2-A00-NN	95B000070	
Polarized retroreflective	0,1...1 m	2m Cable	PNP	SM-PR-2-B00-PP	95B000080	
			NPN	SM-PR-2-B00-NN	95B000090	
Fixed focus (short distance)	15 mm	2m Cable	PNP	SM-PR-2-D00-PP	95B000020	
			NPN	SM-PR-2-D00-NN	95B000030	
Fixed focus (normal distance)	20 mm		PNP	SM-PR-2-D10-PP	95B000140	
			NPN	SM-PR-2-D10-NN	95B000150	
Fixed focus (medium distance)	30 mm		PNP	SM-PR-2-D20-PP	95B000040	
			NPN	SM-PR-2-D20-NN	95B000050	
Fixed focus (long distance)	50 mm		PNP	SM-PR-2-D30-PP	95B000000	
			NPN	SM-PR-2-D30-NN	95B000010	
Through beam receiver	0...2 m		2m Cable	PNP	SM-PR-2-F00-PP	95B000120
				NPN	SM-PR-2-F00-NN	95B000130
		-		SM-PR-2-G00-XG	95B000160	

## ACCESSORIES

### ST-5049

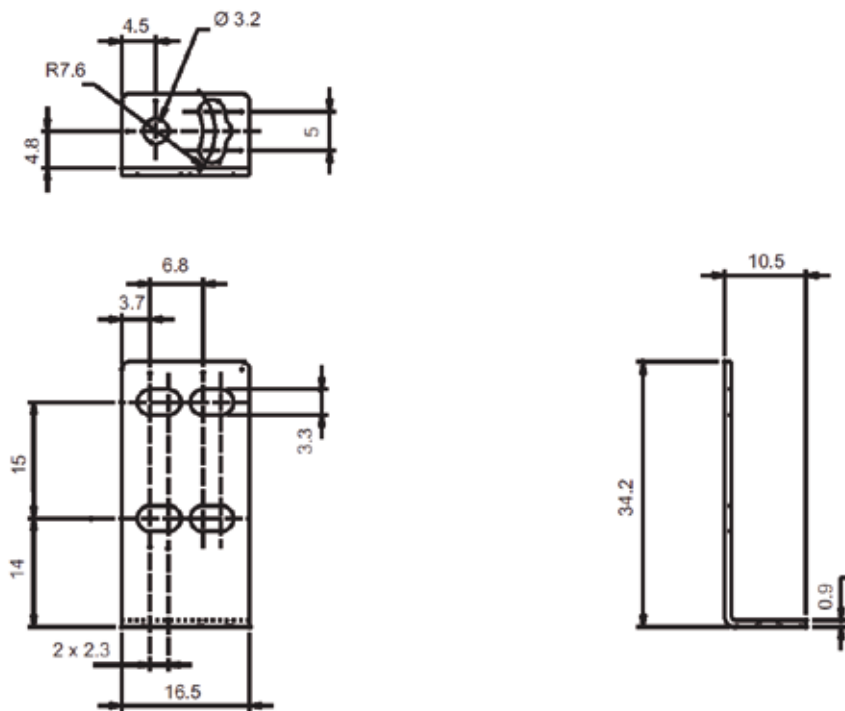

mm

MODEL	DESCRIPTION	ORDER NO.
ST-5049	right angle bracket	95ACC6650